

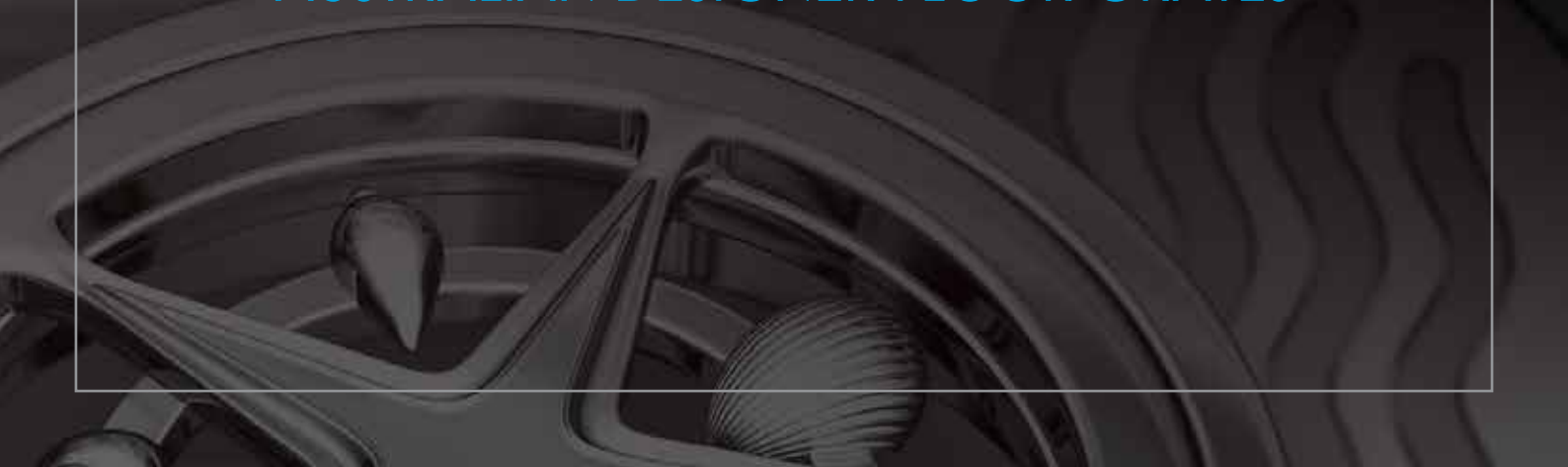

PRODUCT CATALOGUE

AUSTRALIAN DESIGNER FLOOR GRATES



CONTENTS

ABOUT US 3

BERMUDA FLOOR GRATES 5

BERMUDA STANDARD 8

BERMUDA MEGA 8

BERMUDA ROUND & TRIANGLE 9

BERMUDA FLIPPER 10

BERMUDA LEAK CONTROL 11

BERMUDA CHANNEL & CHANNEL WITH GRATE 12

POP DOWN WASTE 12

CLASSIC 13

SS316 18

ACCESSORIES 19



BERMUDA RANGE
FLOOR GRATE



BERMUDA MEGA RANGE
FLOOR GRATE

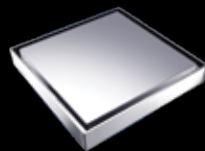

BERMUDA FLIPPER RANGE
FLOOR GRATE



BERMUDA CHANNEL
FLOOR GRATE



SS316 RANGE
FLOOR GRATE

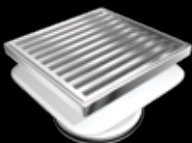

SQUARE ON SQUARE
FLOOR GRATE

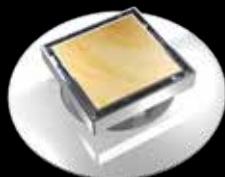

LEAK CONTROL BERMUDA
FLOOR GRATE



NEW ROUND BERMUDA
FLOOR GRATE



CLASSIC RANGE
FLOOR GRATE



POP DOWN WASTE



about us

Designed in Australia, Bounty Brassware floor grates are manufactured to exacting Australian standards using the latest computer controlled casting processes. As a result, we are able to deliver products of the highest quality that integrate beautifully into any bathroom.

The Bounty Brassware range includes our unique and stylish Bermuda range, the Bounty Classic collection, the superior quality and durability SS316 range and our new Square on Square wastes.

If your project is deserving of the ultimate finishing touch, then remember: Bounty Brassware is truly world class!

INTELLECTUAL PROPERTY

Many of our products are protected by their own registered designs, both in Australia and in foreign jurisdictions.

Our tile insert concept has very broad protection in Australia under the granted patent number **AU.2007203019** which does not expire until 2021.

Whilst the patent remains in force, we regard any copies of the tile insert concept to infringe and will take appropriate action as deemed under the licence.





BERMUDA

The flagship of the Bounty Brassware range, the Bermuda floor grate system is a simplistically discreet solution for any bathroom or wet area. Bermuda cleverly incorporates the selected floor tiles (or a feature tile) to blend beautifully with any environment. Water simply disappears from your bathroom / shower floor.

The broad range of Bermuda products ensures that there is a stylish option to compliment your new bathroom. The clever designs make for easy installation.

Standard finish is Chrome, with additional finishes* available upon request:



chrome
(standard)
.01



satin
chrome
.02



gold
plated
.03



polished
brass
.04

*Not applicable to the Bermuda Channel.

BERMUDA STANDARD

The standard Bermuda Floor Grate offers a choice of decorating options! The centre tile recess allows a coordinated tile to be at one with the surrounding floor tiles, in effect disappearing into the overall décor. Alternatively use the centre tile recess to highlight a feature tile or contrasting tile for a spectacular effect. Either way, water will simply and stylishly disappear in front of your very eyes.

Available in 100mm and 80mm connection size, and also with 150mm x 150mm face dimension, each standard Bermuda Floor Grates comes with a stainless strainer.



BERMUDA MEGA

While offering the same exciting decorating options as the standard Bermuda Floor Grate, the Bermuda Mega Floor Grate adds our industry leading Megaflex leak control flange and undercap mortar exclusion device to complement the superior quality and aesthetics of the standard Bermuda Floor Grate, creating a total solution for your project.

The Bermuda Mega floor grates are available in 3 different shapes; square, round and triangle. The square model is available as a 100mm x 100mm or 150mm x 150mm.

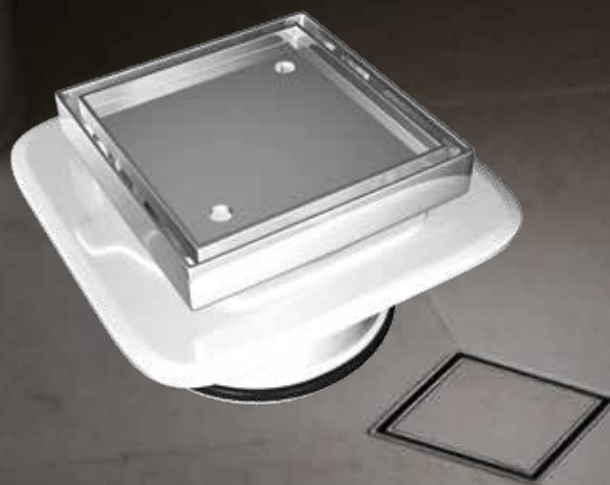

BERMUDA FLIPPER

Building on the options of the standard Bermuda Floor Grate, the Bermuda Flipper with its flippable tile insert adds another level of decorating freedom, making it even easier to create either a coordinated look or a stylish contrasting effect.



BERMUDA LEAK CONTROL

Sharing the same body and face dimension of the 100mm x 100mm Bermuda Mega and the New Round Bermuda Floor Grate, the Bermuda Leak Control Flange incorporate our innovative waterproofing technology; the Leak Control Flange.

Available to fit the 80mm or 50mm leak control flange.

BERMUDA CHANNEL & CHANNEL WITH GRATE

The Bounty Bermuda Channel Floor Grate range offers clean lines and superior durability that only 316 stainless steel can deliver. Incorporating our industry leading Megaflex leak control flange, it ensures a total solution for your project. Perfect installation is no longer impossible with the adjustability of height and tilt, while enabling positive engagement with your waterproof membrane for total peace of mind.

Fully customisable – the Bounty Bermuda Channel Floor Grate can be made to any size your project requires, and also comes in standard lengths of 300mm, 600mm, 900mm and 1200mm at a width of 100mm.



POP DOWN WASTE

LOOKS BETTER. *IS BETTER!*

- **At Last** – a quick close waste that is approved for basins and baths giving you a consistent look throughout your bathroom.
- **Looks Fantastic** - Sits flush in the most commonly used 'open position' for a superior aesthetic.
- **Works Brilliantly** – super smooth opening and closing, along with easy to remove cartridge for cleaning and drain access.

Pop Down waste in
closed position

Pop Down waste in
open position

- Suits basins with 32mm or 40mm outlet provision with or without overflow.
- Innovative quick remove cartridge with high tech polymer fins ensures a lifetime of trouble free operation.
- Perfect in baths with no protruding parts to catch fingers and toes.
- Lifetime Replacement Guarantee on cartridge.
- Worldwide Patent Pending.
- Registered Design

BERMUDA FLOOR GRATE

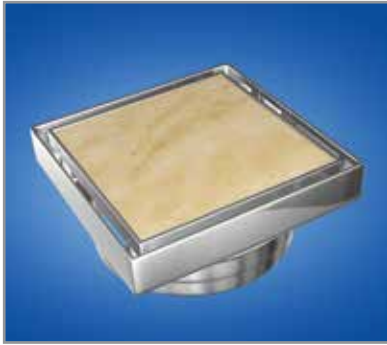

TECHNICAL SPECIFICATION

FLOW RATE:

115 x 100:	> 105L/min
115 x 80:	> 64L/min

MATERIAL(s):

Tile Insert:	Brass
Base:	Brass
Strainer:	Stainless Steel

STANDARD FINISH: Chrome Plated (ASTD 1192-2004)

APPROVAL:

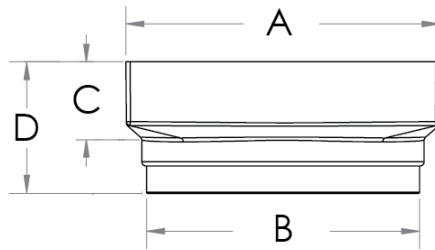

CODES	A	B	C	D
11101.01	115	100.0	28	48
11102.01	115	74.8	28	48

DESCRIPTION	CODE	FINISH	QTY/CTN
115x100mm Square CP	11101.01	Chrome	20
115x80mm Square CP	11102.01	Chrome	20

Available in chrome, satin chrome, gold plated and polished brass.

BERMUDA MEGA SQUARE FLOOR GRATE

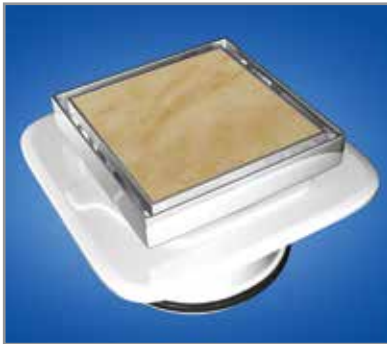

TECHNICAL SPECIFICATION

FLOW RATE: Round

100mm Connection:	> 105L/min
80mm Connection:	> 90L/min
50mm Connection:	> 60L/min

MATERIAL(s):

Tile Insert:	Brass
Base:	Brass
MegaFlex Base:	A.B.S.

STANDARD FINISH: Chrome Plated (ASTD 1192-2004)

APPROVAL:

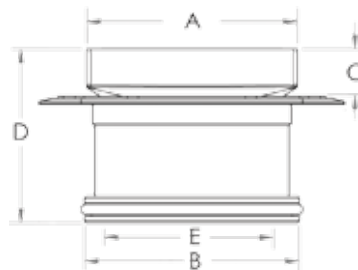

CODES	A	B	C	D	E
11203.01	100	102.8	27	87.5	85
11204.01	100	75	27	76	61
11205.01	100	50.8	27	65	42
11213.01	100	102	23	82	86
11214.01	100	75	23	72	63
11215.01	100	50.8	23	61	42
11412.01	149.5	102.8	20	34	NA
11422.01	150	102.8	39	99	85

DESCRIPTION	CODE	FINISH	QTY/CTN
100x100mm Mega Square CP	11203.01	Chrome	20
100x80mm Mega Square CP	11204.01	Chrome	20
100x50mm Mega Square CP	11205.01	Chrome	20
100x100mm Lowline Mega Square CP	11213.01	Chrome	20
100x80mm Lowline Mega Square CP	11214.01	Chrome	20
100x50mm Lowline Mega Square CP	11215.01	Chrome	20
150x100mm Bermuda Deluxe Sq CP	11412.01	Chrome	16
150x100mm Mega Bermuda Deluxe Sq CP	11422.01	Chrome	16

Available in chrome, satin chrome, gold plated, polished brass and black chrome.

Refer page ii for finish codes.

Incorporates MegaFlex Leak Control Flange for superior waterproofing and flexibility of installation.

BERMUDA MEGA ROUND FLOOR GRATE



TECHNICAL SPECIFICATION

FLOW RATE: Round

- 100mm Connection: > 105L/min
- 80mm Connection: > 90L/min
- 50mm Connection: > 60L/min

FLOW RATE: Bold

- 100mm Connection: > 72L/min

MATERIAL(s):

- Tile Insert: Brass
- Base: Brass
- Megaflex Base: A.B.S.

STANDARD FINISH: Chrome Plated (ASTD 1192-2004)

APPROVAL:

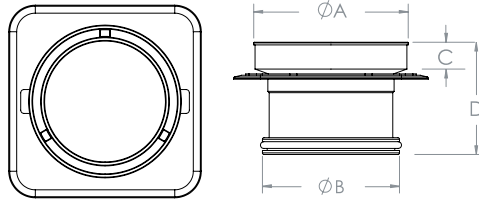

CODE	A	B	C	D
11151.01	115.0	102.0	22.0	81.7
11351.01	115.0	102.0	23.5	86.0
11352.01	115.0	75.0	24.0	76.6
11353.01	115.0	50.8	24.8	61.3

DESCRIPTION	CODE	FINISH	QTY/CTN
115x100mm Mega Round Bold w/ undercap CP	11151.01	Chrome	20
115x100mm Mega Round CP	11351.01	Chrome	20
115x80mm Mega Round CP	11352.01	Chrome	20
115x50mm Mega Round CP	11353.01	Chrome	20

Available in chrome, satin chrome, gold plated and polished brass.
Refer page 4 for finish codes.

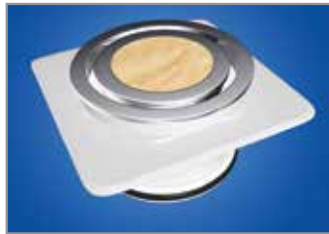

BERMUDA MEGA ROUND BOLD FLOOR GRATE

FLOW RATES:

- 100mm Connection: >72L/min

STANDARD FINISH: Chrome plate (ASTD 1192-2004)

BERMUDA MEGA TRIANGLE FLOOR GRATE

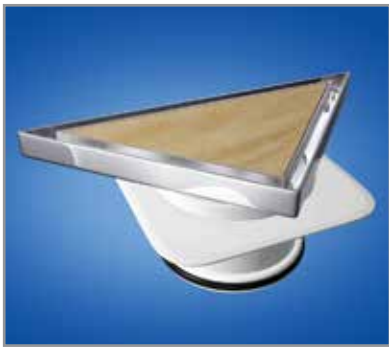

TECHNICAL SPECIFICATION

FLOW RATE:

- 100mm Connection: > 50L/min
- 80mm Connection: > 45L/min

MATERIAL(s):

- Tile Insert: Brass
- Base: Brass
- Connector: Polypropylene
- Megaflex Base: A.B.S.

STANDARD FINISH: Chrome Plated (ASTD 1192-2004)

APPROVAL:

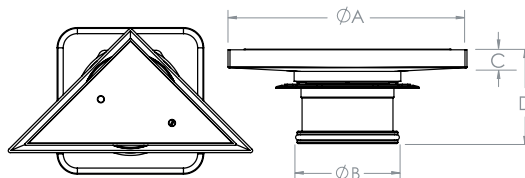

CODE	A	B	C	D
11701.01	248.5	102.0	18.0	95.5
11702.01	248.5	75.0	18.0	82.0

DESCRIPTION	CODE	FINISH	QTY/CTN
175x100mm Mega Triangle CP	11701.01	Chrome	20
175x80mm Mega Triangle CP	11702.01	Chrome	20

Available in chrome, satin chrome, gold plated and polished brass.
Refer page 4 for finish codes.

BERMUDA FLIPPER ROUND FLOOR GRATE



TECHNICAL SPECIFICATION

FLOW RATE:

100mm Connection: > 105L/min
 80mm Connection: > 90L/min
 50mm Connection: > 60L/min

MATERIAL(s):

Tile Insert: Brass
 Base: Brass
 Megaflex Base: A.B.S.

STANDARD FINISH: Chrome Plated
 (ASTD 1192-2004)

APPROVAL:

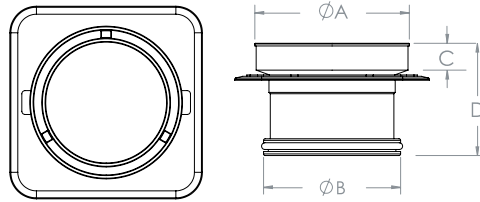

CODE	A	B	C	D
11501.01	115.0	102.0	23.5	86.0
11502.01	115.0	75.0	24.0	76.6
11503.01	115.0	50.8	24.8	61.3

DESCRIPTION	CODE	FINISH	QTY/CTN
100mm Mega Flipper Round CP	11501.01	Chrome	20
80mm Mega Flipper Round CP	11502.01	Chrome	20
50mm Mega Flipper Round CP	11503.01	Chrome	20

Available in chrome, satin chrome, gold plated and polished brass.
 Refer page 4 for finish codes.

BERMUDA FLIPPER SQUARE FLOOR GRATE

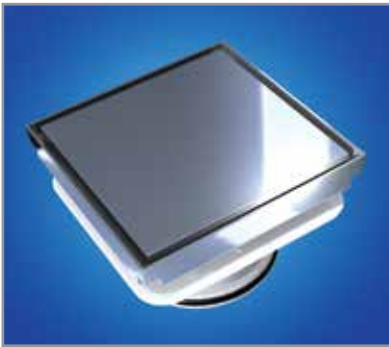

TECHNICAL SPECIFICATION

FLOW RATE:

100mm Connection: > 70L/min

MATERIAL(s):

Tile Insert: Brass
 Base: Brass
 Megaflex Base: A.B.S.

STANDARD FINISH: Chrome Plated
 (ASTD 1192-2004)

APPROVAL:

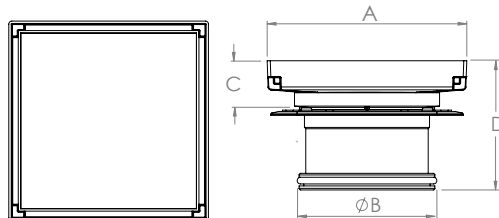

CODE	A	B	C	D
11411.01	150	102.8	34	N/A
11421.01	150	102.8	39	99

DESCRIPTION	CODE	FINISH	QTY/CTN
150x100mm Bermuda Deluxe Flipper Sq CP	11411.01	Chrome	20
150x100mm Bermuda Mega Deluxe Flipper Sq CP	11421.01	Chrome	20

Available in chrome, satin chrome, gold plated and polished brass.
 Refer page 4 for finish codes.

BERMUDA LEAK CONTROL FLOOR GRATE

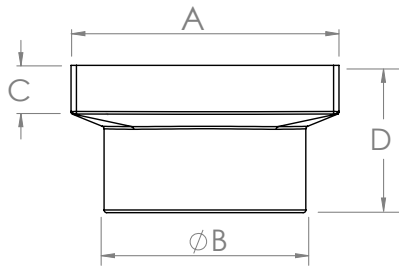
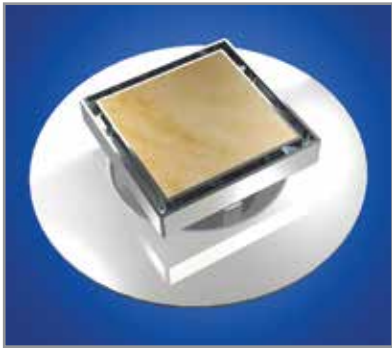

CODE	A	B	C	D
11801.01	100.0	55.0	18.0	75.3
11851.01	115.0	55.0	20.0	75.3

DESCRIPTION	CODE	FINISH	QTY/CTN
100x80mm Square Leak Control CP	11801.01	Chrome	20
115x80mm Round Leak Control CP	11851.01	Chrome	20

Available in chrome, satin chrome, gold plated and polished brass.
Refer page 4 for finish codes.

Puddle flange sold separately.

TECHNICAL SPECIFICATION

FLOW RATE:

- Square: > 90L/min
- Round: > 70L/min

MATERIAL(s):

- Tile Insert: Brass
- Body: Brass
- Undercap: Polypropylene
- Puddle Flange: A.B.S.

STANDARD FINISH: Chrome Plated (ASTD 1192-2004)

APPROVAL:



PUDDLE FLANGE (sold separately)

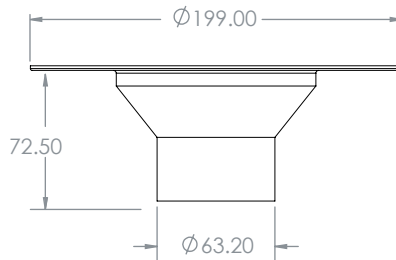

80mm x 50mm Socket

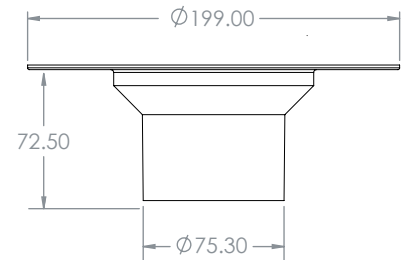

80mm InPipe

DESCRIPTION	CODE	FINISH	QTY/CTN
Puddle Flange 80mm x 50mm Socket	32201	White	60
Puddle Flange 80mm In Pipe	32211	White	60

BERMUDA CHANNELS



11922.12



316 Stainless Steel

Incorporates the Megaflex Leak Control Flange for superior waterproofing and flexibility of installation.

Innovative legs to stop the tray from rattling and to keep it centralised.

FLOW RATE:

- 100mm : > 105L/min
- 80mm : > 90L/min
- 50mm : > 60L/min
- 100mm : > 105L/min
- 80mm : > 90L/min
- 50mm : > 60L/min
- 100mm : > 105L/min
- 80mm : > 90L/min
- 50mm : > 60L/min

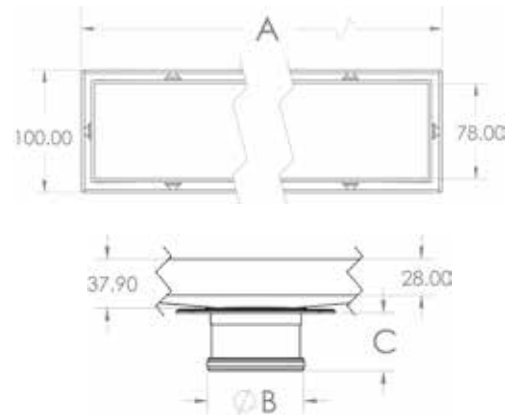
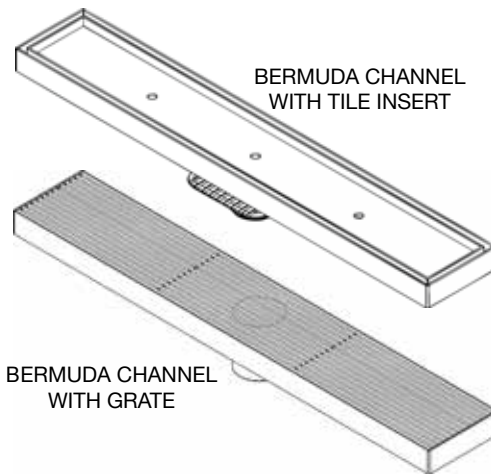

DESCRIPTION	BERMUDA CHANNEL CODE	BERMUDA GRATE CODE	A	B	C	FINISH
300 x 50 mm	11901.12	11951.12	300.0	52.5	33.0	St/Steel
300 x 80 mm	11902.12	11952.12	300.0	75.0	56.0	St/Steel
600 x 50 mm	11911.12	11961.12	600.0	52.5	33.0	St/Steel
600 x 80 mm	11912.12	11962.12	600.0	75.0	56.0	St/Steel
900 x 50 mm	11921.12	11971.12	900.0	52.5	33.0	St/Steel
900 x 80 mm	11922.12	11972.12	900.0	75.0	56.0	St/Steel
1000 x 50 mm	11931.12	11981.12	1000.0	52.5	33.0	St/Steel
1000 x 80 mm	11932.12	11982.12	1000.0	75.0	56.0	St/Steel
1200 x 50 mm	11941.12	11991.12	1200.0	52.5	33.0	St/Steel
1200 x 80 mm	11942.12	11992.12	1200.0	75.0	56.0	St/Steel

POP DOWN WASTE



Worldwide Patent Pending Registered Design

TECHNICAL SPECIFICATION

FLOW RATE:

115 x 100: > 12L/min

MATERIAL(s): Brass

STANDARD FINISH: Chrome Plated (ASTD 1192-2004)

APPROVAL:

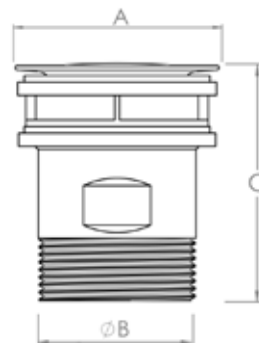

CODES	A	B	C
21800.01	62.1	34.5	86
21801.01	62.1	40.5	86

DESCRIPTION	CODE	FINISH	QTY/CTN
32mm Brass Pop Down CP	21800.01	Chrome	32
40mm Brass Pop Down CP	21801.01	Chrome	32

Available in chrome, satin chrome, gold plated and polished brass. Refer page 4 for finish codes.



CLASSIC

CLASSIC FLOOR GRATE

A floor grate does not have to be just a floor grate. Whilst keeping the durability, high quality and careful manufacturing processes, the designer brass Bounty Classic range provides the harmony between aesthetics and functionality with its uniquely timeless and thematic designs.

All Bounty Classic designs are available with either round or square base. Standard finish is Chrome, with additional finishes available upon request.



chrome
(standard)
.01



satin
chrome
.02



gold
plated
.03



polished
brass
.04

CLASSIC FEDERATION FLOOR GRATE



TECHNICAL SPECIFICATION

MATERIAL(s):

Grate: Brass
Base: Brass

STANDARD FINISH: Chrome
(ASTD 1192-2004)

APPROVAL:



DESCRIPTION	CODE	HOUSING	FINISH
100mm Federation Round CP	12101.01	A	Chrome
100mm Federation Square CP	12102.01	B	Chrome
80x50mm Federation Round CP	12103.01	C	Chrome
80x50mm Federation Square CP	12104.01	D	Chrome
80mm Federation Round CP	12105.01	E	Chrome
80mm Federation Square CP	12106.01	F	Chrome
50mm Federation Mega Flex Round CP	12107.01	G	Chrome
50mm Federation Mega Flex Square CP	12108.01	H	Chrome
80x50mm Federation SBW CP	12110.01	I	Chrome

Available in chrome, satin chrome, gold plated and polished brass.
Refer page 13 for finish codes and page 16 for dimensions.

CLASSIC PLAIT FLOOR GRATE



TECHNICAL SPECIFICATION

MATERIAL(s):

Grate: Brass
Base: Brass

STANDARD FINISH: Chrome
(ASTD 1192-2004)

APPROVAL:



DESCRIPTION	CODE	HOUSING	FINISH
100mm Plait Round CP	12201.01	A	Chrome
100mm Plait Square CP	12202.01	B	Chrome
80x50mm Plait Round CP	12203.01	C	Chrome
80x50mm Plait Square CP	12204.01	D	Chrome
80mm Plait Round CP	12205.01	E	Chrome
80mm Plait Square CP	12206.01	F	Chrome
50mm Plait Mega Flex Round CP	12207.01	G	Chrome
50mm Plait Mega Flex Square CP	12208.01	H	Chrome
80x50mm Plait SBW CP	12210.01	I	Chrome

Available in chrome, satin chrome, gold plated and polished brass.
Refer page 13 for finish codes and page 16 for dimensions.

CLASSIC STARFISH FLOOR GRATE



TECHNICAL SPECIFICATION

MATERIAL(s):

Grate: Brass
Base: Brass

STANDARD FINISH: Chrome
(ASTD 1192-2004)

APPROVAL:



DESCRIPTION	CODE	HOUSING	FINISH
100mm Starfish Round CP	12301.01	A	Chrome
100mm Starfish Square CP	12302.01	B	Chrome
80x50mm Starfish Round CP	12303.01	C	Chrome
80x50mm Starfish Square CP	12304.01	D	Chrome
80mm Starfish Round CP	12305.01	E	Chrome
80mm Starfish Square CP	12306.01	F	Chrome
50mm Starfish Round Mega Flex CP	12307.01	G	Chrome
50mm Starfish Square Mega Flex CP	12308.01	H	Chrome
80x50mm Starfish SBW CP	12310.01	I	Chrome

Available in chrome, satin chrome, gold plated and polished brass.
Refer page 13 for finish codes and page 16 for dimensions.

CLASSIC RIPPLE FLOOR GRATE



TECHNICAL SPECIFICATION

MATERIAL(s):

Grate: Brass
Base: Brass

STANDARD FINISH: Chrome
(ASTD 1192-2004)

APPROVAL:



DESCRIPTION	CODE	HOUSING	FINISH
100mm Ripple Round CP	12401.01	A	Chrome
100mm Ripple Square CP	12402.01	B	Chrome
80x50mm Ripple Round CP	12403.01	C	Chrome
80x50mm Ripple Square CP	12404.01	D	Chrome
80mm Ripple Round CP	12405.01	E	Chrome
80mm Ripple Square CP	12406.01	F	Chrome
50mm Ripple Round Mega Flex CP	12407.01	G	Chrome
50mm Ripple Square Mega Flex CP	12408.01	H	Chrome
80x50mm Ripple SBW CP	12410.01	I	Chrome

Available in chrome, satin chrome, gold plated and polished brass.
Refer page 13 for finish codes and page 16 for dimensions.

HOUSINGS

100mm BAYONET SHORT TAIL (PLASTIC EXTENSION AVAILABLE)

HOUSING A

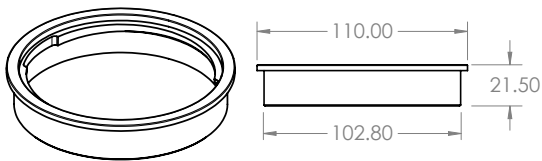

HOUSING B

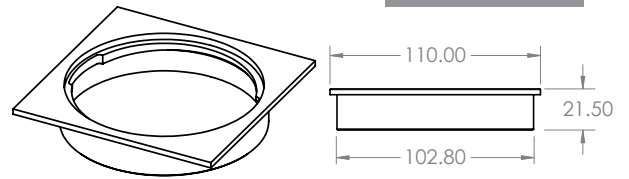

80x50mm REDUCING SCREW GRATE

HOUSING C

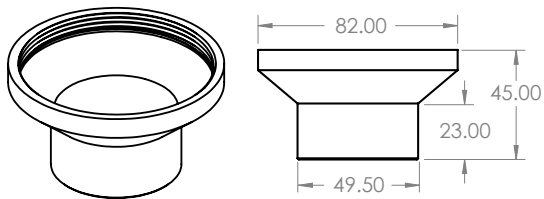

HOUSING D

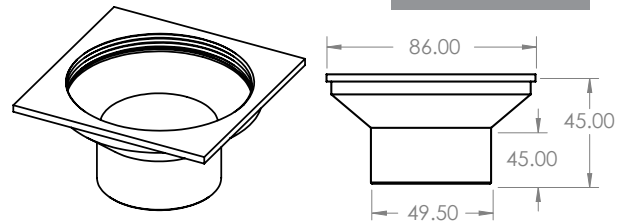

80mm SCREW GRATE LONGTAIL CONNECTION

HOUSING E

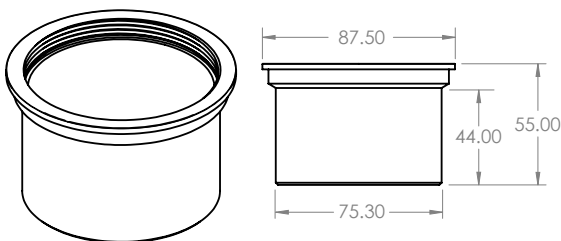

HOUSING F

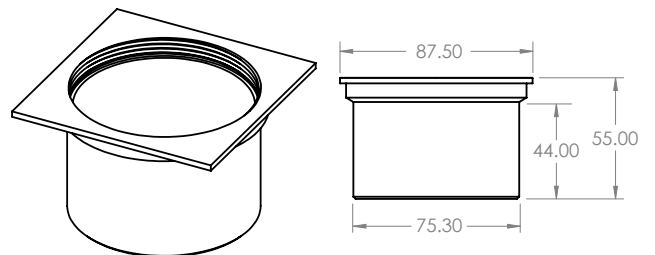

80mm x 50mm MEGAFLEX SCREW GRATE WITH FLANGE

HOUSING G

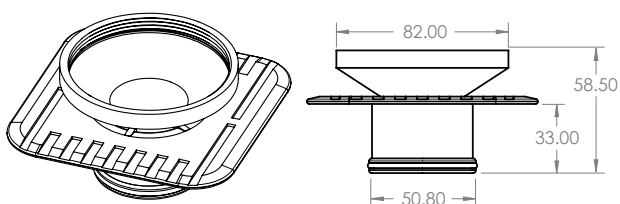

HOUSING H

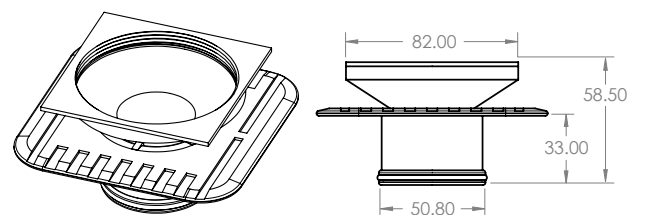

80mm x 50mm SHOWER BASE

HOUSING I

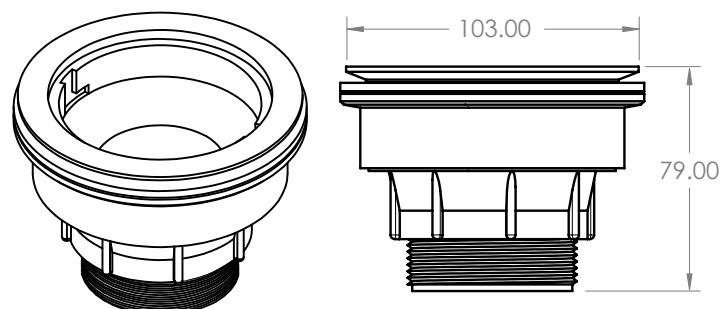



SS316

SS316 FLOOR GRATE

The Bounty SS316 Floor Grate range gives the greatest peace of mind of any floor waste available. Made from marine grade 316 Stainless Steel, these grates will not rust, peel or tarnish.

Available in either Round or Square, sizes include 100mm, 80mm, 80mm x 50mm and 50mm (Australian sizes). Also available, the 100mm and 80mm version with the renowned Mega Flex leak control system.



SQUARE ON SQUARE FLOOR GRATE

The Bounty Square on Square Floor Grate range offers clean lines and superior durability that only 316 stainless steel can deliver. Incorporating our industry leading Megaflex leak control flange and undercap mortar exclusion device, it ensures a total solution for your project. Perfect installation is no longer impossible with the adjustability of height and tilt while enabling positive engagement with your waterproof membrane for total peace of mind.

No longer will you be forced to use a round waste in a square body that just does not fit with the design aesthetic of your project. No more square pegs in round holes! The Bounty Square on Square Mega Floor Grate delivers a truly square floor grate.

316 STAINLESS STEEL ROUND



MATERIAL(s):

Grate: 316 Stainless Steel
Base: 316 Stainless Steel

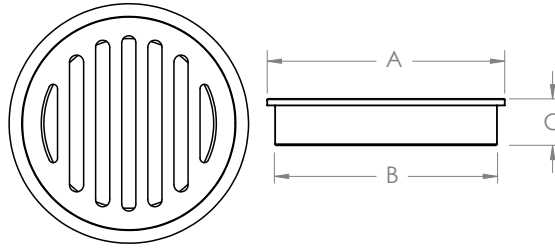

CODE	A	B	C
13101.12	110.0	102.8	21.5
13102.12	86.0	74.5	20.0
13103.12	82.0	49.5	45.0
13105.12	66.0	50.3	22.0

DESCRIPTION	CODE	FINISH	QTY/CTN
100mm Round SS Polished	13101.12	Polished SS	50
80mm Round SS Polished	13102.12	Polished SS	120
50mm Round SS Polished	13105.12	Polished SS	100

316 STAINLESS STEEL SQUARE



MATERIAL(s):

Grate: 316 Stainless Steel
Base: 316 Stainless Steel

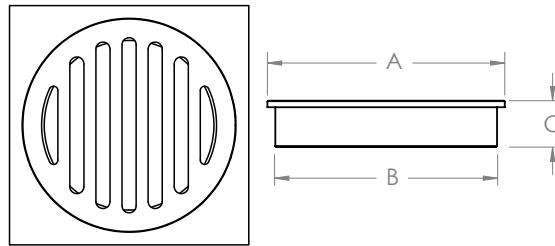

CODE	A	B	C
13201.12	110.0	102.8	21.5
13203.12	86.0	74.5	20.0
13204.12	82.0	49.5	45.0
13206.12	66.0	50.3	22.0

DESCRIPTION	CODE	FINISH	QTY/CTN
100mm Square SS Polished	13201.12	Polished SS	50
80mm Square SS Polished	13203.12	Polished SS	120
50mm Square SS Polished	13206.12	Polished SS	100

316 STAINLESS STEEL SQUARE ON SQUARE MEGAFLEX



MATERIAL(s):

Grate: 316 Stainless Steel
Base: 316 Stainless Steel

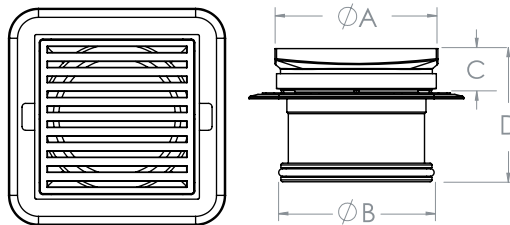

CODE	A	B	C	D
13301.12	110.0	102.0	29.9	89.9
13302.12	110.0	75.0	29.4	78.4

DESCRIPTION	CODE	FINISH	QTY/CTN
100x100mm Sq on Sq Pol SS Mega	13301.12	Polished SS	20
100x80mm Sq on Sq Pol SS Mega	13302.12	Polished SS	20

316 STAINLESS STEEL MEGAFLEX



MATERIAL(s):

Grate: 316 Stainless Steel
Base: 316 Stainless Steel

APPROVAL:  AUSTRALIAN
QUALITY
CERTIFIED

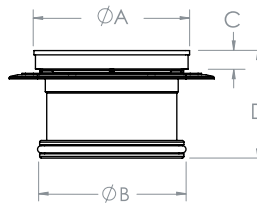
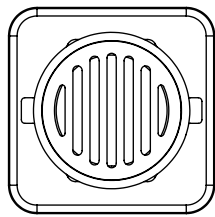

CODE	A	B	C	D
13401.12	110.0	102.0	13.0	76.0
13402.12	110.0	102.0	13.0	76.0

DESCRIPTION	CODE	FINISH	QTY/CTN
100mm Round Mega SS Polished	13401.12	Polished SS	20
100mm Square Mega SS Polished	13402.12	Polished SS	20

ACCESSORIES SMELL STOPPER



MATERIAL(s):

Grate: A.B.S.
Base: A.B.S.

APPROVAL:  AUSTRALIAN
QUALITY
CERTIFIED

DESCRIPTION	CODE	FINISH	QTY/CTN
100mm Smell Stopper	34611	Silver	100
100mm Smell Stopper (without retrofit flange)	34612	Silver	100



Distributed by:



www.bountybrassware.com.au

Bounty Bermuda, Bermuda Mega, Bermuda Flipper, Square on Square, Pop Down Waste, Classic and SS316 ranges
are designed by
Bounty Brassware

Copyright © Bounty Brassware